

Article number: 12712000030700  
Description: KLEE-coil 712 000 030.700  
M3 Light-alloy metal

## Measures

---

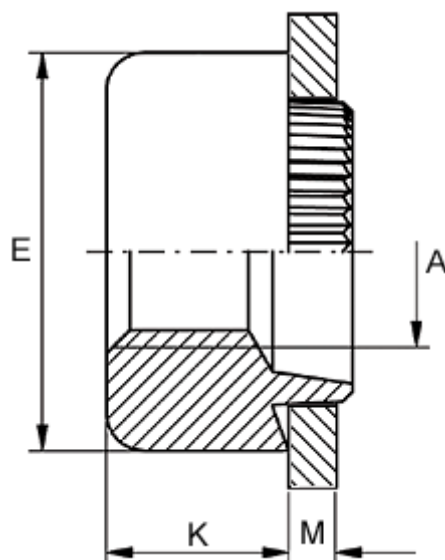

Female thread A	= M3
Height K	= 3.0
Outer diameter E	= 8.0
Plate thickness	= 3.2 to 3.4
Recommended bore diameter for extreme load	= 6.0
Recommended bore diameter for normal use	= 6.0